

DOUBLE-WALL POLYGON TANK SUMP

MODEL DW PTS (WT34) 48/8-3SBS

(Short Bury Watertight Turbine Sump)

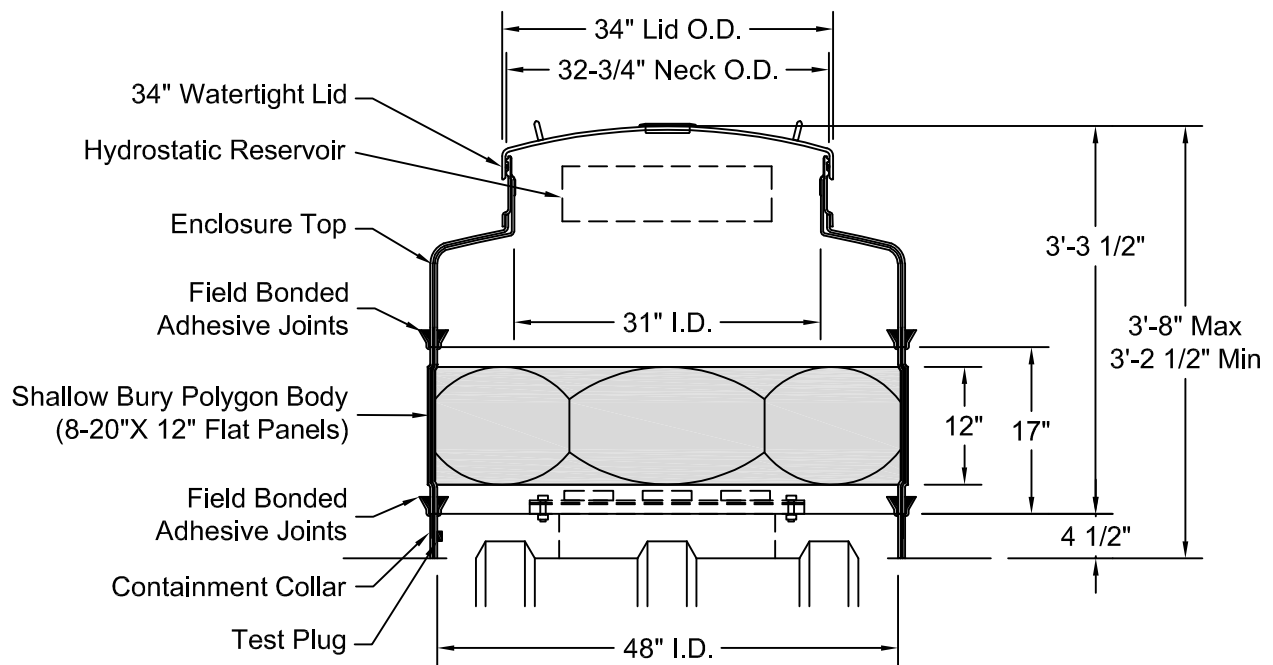
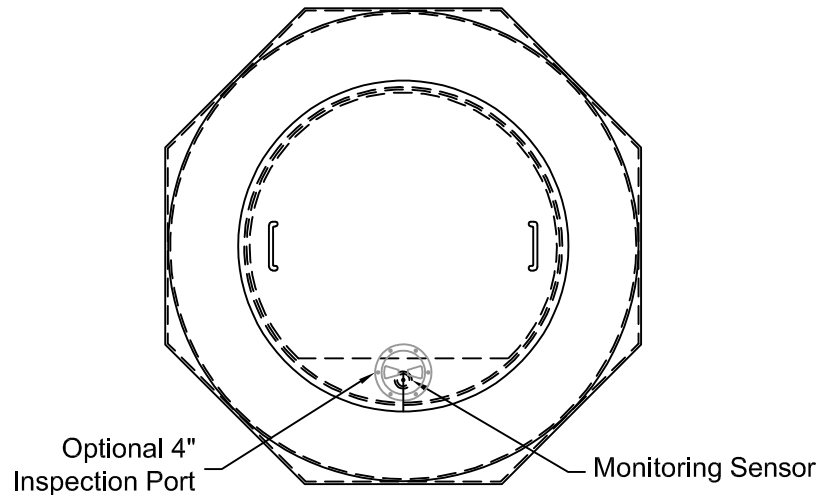

Approval Signature: _____
Approval Date: _____
Project Name: _____
P.O Number: _____
Qty Req'd: _____



CONTAINMENT
SOLUTIONS®

DW PTS (WT34) 488-3SBS.DWG
1/1/2012-12/2015