

Fiberglass Aboveground Water Storage Tank Model RWH AGT (6') 1,250

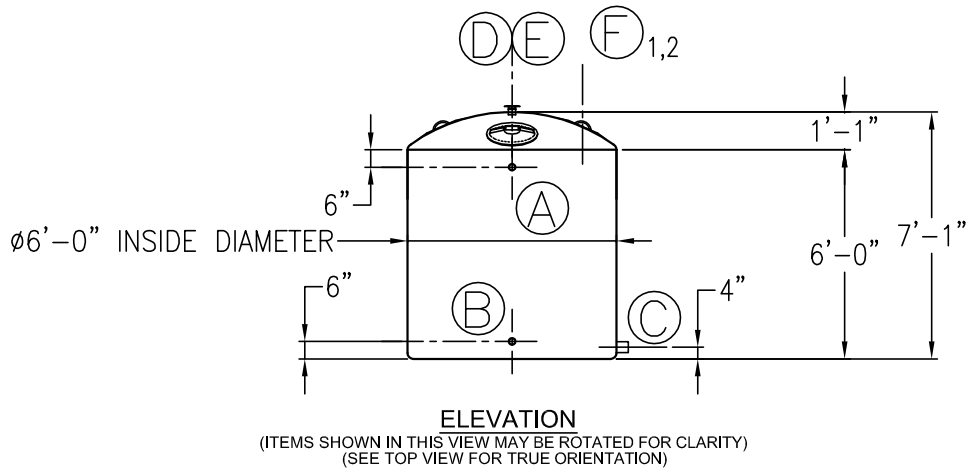
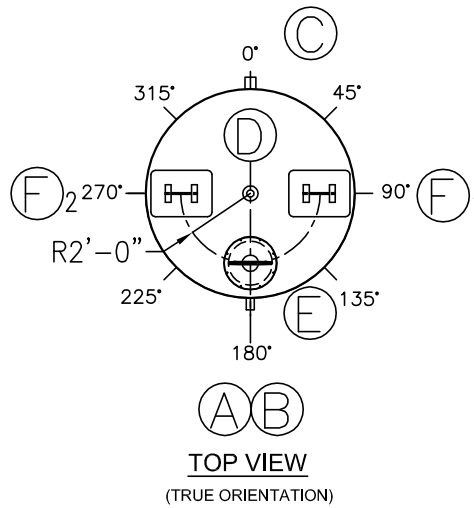

SCHEDULE OF FITTINGS AND ACCESSORIES

MARK	QTY.	SIZE	TYPE	DESCRIPTION	REMARKS
(A)	1	ø2"	FRP	FNP THREADED HALF COUPLING	FILL-LINE CONNECTION
(B)	1	ø2"	FRP	FNP THREADED HALF COUPLING	FILL-LINE CONNECTION
(C)	1	ø3"	FRP	FNP THREADED HALF COUPLING	DRAIN-LINE CONNECTION
(D)	1	ø2"	POLY	SCREW ON TOP POLY VENT	VENT
(E)	1	ø18"	POLY	SCREWED ON TOP MANWAY	INSPECTION
(F)	2	STD	STL	LIFTING LUG	ZINC-PLATED
(G)					
(H)					
(I)					

Available Finishes (Choose One)

- Desert Sand Premium Finish
- Forest Green Premium Finish



CONTAINMENT SOLUTIONS®

File: P:\JODY HARMON\Logo's for Drawings\CSL_horizontal for Jodi final.pdf
Warning for invalid reference

PROJECT NAME/LOCATION:			6'-0"Ø x 7'-1" 1,250 GALLONS			DATE: 1/1/2014	
APPROVAL SIGNATURE:	SIGNATURE DATE:	DRAWN BY: R.MOEN	REV #:	REV DATE:	REV BY:	DWG NUMBER: RWH AGT(72)-1250.DWG	